

PROTEGO® Deflagration Flame Arresters End-of-Line and Vent Caps

Section 2



Section 2



for safety and environment



Function and description

The different combustion processes and installation locations of flame arresters are discussed in "Technical Fundamentals" (Sec. 1). This section discusses the PROTEGO® product range for end-of-line deflagration flame arresters and vent caps. These devices protect against atmospheric deflagration, atmospheric deflagration and short time burning, or atmospheric deflagration and endurance burning, which also includes short time burning. Vent caps without flame arrester elements complete our range of end-of-line devices.

PROTEGO® end-of-line deflagration flame arresters are state-of-the-art safety devices which are installed on storage tanks, vessels, or in process plants. They provide safe protection against atmospheric deflagration, short time burning or endurance burning if potentially explosive vapors are released. They reduce the impact of atmospheric deflagration and prevent flame transmission to protect equipment which is not designed to be explosion pressure-proof.

The main component is the PROTEGO® flame arrester unit (1) which stops the propagation of flames. The PROTEGO® flame arrester unit consists of one or two FLAMEFILTER® discs which are secured in a FLAMEFILTER® casing (3). The gap size and number of FLAMEFILTER® discs depend on the operating parameters of the mixture that is flowing through (i.e., explosion group, pressure, temperature, composition of the product).

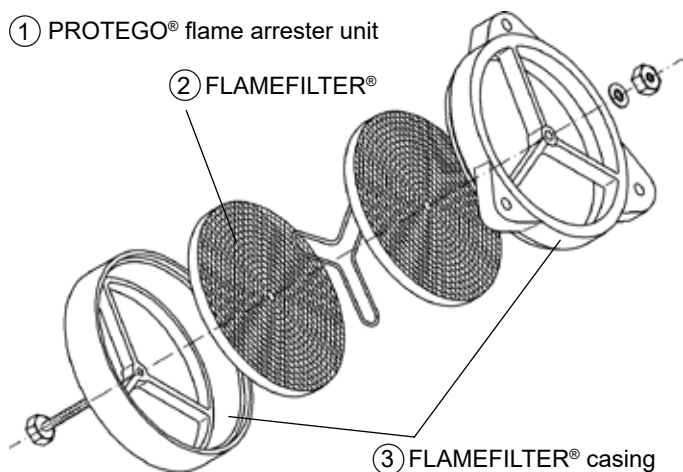

Deflagration and short time burning proof end-of-line flame arresters are equipped with a temperature sensor which detects a stabilized flame on the flame arrester element. If a flame is detected, measures have to be taken to extinguish the flame and prevent endurance burning.

Should venting of an explosive mixture over a long period of time be unavoidable, and no secondary measure is implemented to extinguish a flame, devices which provide endurance burning protection shall be installed. **Deflagration and endurance burning proof end-of-line flame arresters** from PROTEGO® are equipped with a melting element which melts if a flame stabilizes on the flame arrester element and then allows the weather hood to open. This allows the flame to transfer most of its heat directly to the environment, and a flashback is prevented by the FLAMEFILTER®.

Vent caps without flame arrester elements protect against environmental impact (harsh weather conditions, foreign bodies, and nesting animals) complete our product range.

In close cooperation with scientific institutions, PROTEGO® has developed safety devices which can be applied to all explosion hazardous locations and provide protection against atmospheric deflagration, short time burning, and endurance burning. Our devices are subjected to and certified by type examination according to ATEX and other international standards (CE, Gost-R, GL, etc.).

A wide range of types, designs, sizes, and materials can be provided. Most importantly, we have the capability to custom design and develop solutions at our test facility, which is the most technologically advanced in the world.

Special features and advantages

The following factors should be considered for selecting a device: **Deflagration protection, deflagration and short time burning protection**, including temperature control, or **deflagration and endurance burning protection**. **Vent caps** do not have a FLAMEFILTER®.

Regarding operating conditions, **higher temperatures** have to be considered if standard values for atmospheric operation are exceeded.

For selecting a suitable device, the components should be classified into **explosion groups** according to their MESG value.

The suitable **approval** must be chosen.

The system specification needs to be considered when selecting the appropriate connection and **size**.

Depending on the application, it may be important to select a device with a **heating jacket** or heating coil, but please note that not all devices are available with this feature. Electrical trace heating may be an alternative.

We provide special designs for critical substances and product properties (e.g., viscosity, density, crystallization, and polymerization).

Preferred applications

PROTEGO® end-of-line deflagration flame arresters and vent caps are typically installed on storage tanks and vessels of the chemical, petrochemical, and pharmaceutical industries for protection.

Installation and maintenance

The modular design of the end-of-line deflagration flame arresters assures the easiest possible maintenance. For onsite maintenance purposes, the device has to be installed in a location where it can easily be accessed. For larger sizes, it may be necessary to provide lifting equipment. Maintenance is trouble-free for trained personnel.

PROTEGO® end-of-line deflagration flame arresters are installed in areas subject to explosion hazards. It is important to select the correct device for the specific application. The manufacturer's statement of conformity confirms the tasks for which the deflagration flame arrester is suitable. The user documents proper use in accordance with the applicable safety regulations.

Selection

Based on main process data, the different types of devices can be selected from our product range:

- **Atmospheric deflagration-proof, short time burning-proof, endurance burning-proof, or vent caps**
- **Explosion group** of the processed mixture
- Standard or special operating conditions with **higher temperatures**

Subsequently, the following criteria has to be verified or selected:

- **Size** and type of connection
- **Approvals** according to ATEX, etc.
- **Heating jacket** or heating coil

Other details, such as material, coating etc., can be selected or defined on the data sheet after pre-selection.

If no suitable device can be found, please contact us. Special designs and approvals are available.

Sizing

The volume flow/pressure drop diagram shows the determined or checked nominal size of the device. If it is likely that the FLAMEFILTER® can become clogged, a safety factor should be considered for sizing.

Given: Flow rate \dot{V} m³/h or CFH
max. all. pressure drop Δp in mbar or inch W.C.

Desired: Size of the device DN

Procedure: Intersection point of straight lines through the flow rate and maximum allowable pressure drop is above or at the size curve

Given: Flow rate \dot{V} m³/h or CFH
size of nozzle connection DN

Desired: Pressure drop (flow resistance)
 Δp in mbar or inch W.C.

Procedure: Intersection point of the straight line through the flow rate and size curve, horizontal straight line provides the pressure drop

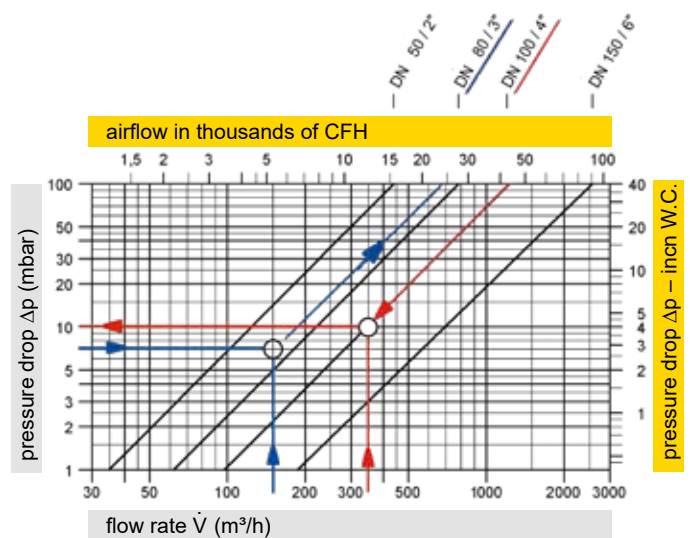









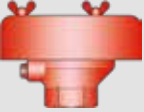

Instructions for calculating the volume flow or influence of density is covered in the "Technical Fundamentals" (see Sec. 1).

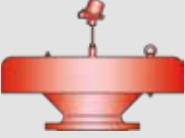

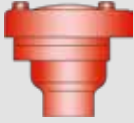











After all the steps are completed, the device can be specified and ordered.

For special applications, please complete the data sheet from Section 1 and provide the necessary information for a quotation.



PROTEGO® Deflagration Flame Arresters, End-of-Line, and Vent Caps

	Type	Size DN	Explosion group		Approvals	X = Special design for higher temperatures	X = Heating jacket / heating coil	Page
			ATEX	NEC				
Deflagration flame arrester, end-of-line								
	BE/AD	15 - 50 ½" - 2"	IIB3, IIC	C B	ATEX			64 - 66
	LH/AD	50 - 800 2" - 32"	IIB3, IIC	C B	ATEX	X		68 - 70
Deflagration flame arrester, short time burning-proof, end-of-line								
	LH/AD-T	50 - 800 2" - 32"	IIB3, IIC	C B	ATEX	X		72 - 74
Deflagration flame arrester, endurance burning-proof, end-of-line								
	EB	25 - 800 1" - 32"	IIA, IIB	D B	ATEX			76 - 79
	EB-DN/DN2	20 - 700 ¾" - 28"	IIA, IIB	D B	ATEX	X	X	76 - 79
	EB-Z	15 - 32 ½" - 1¼"	IIA	D	ATEX			
	BE/HK	20 - 80 ¾" - 3" 20 - 32 ¾" - 1¼"	IIA, IIB3	D C	ATEX		X	
	BE/HK-E	20 - 80 ¾" - 3"	IIB1	-	ATEX		X	80 - 81
	BE-HK-E	80 3"	IIB3	C	ATEX IMO		X	

	Type	Size DN	Explosion group		Approvals	X = Special design for higher temperatures	X = Heating jacket/ heating coil	Page
			ATEX	NEC				
Deflagration flame arrester, endurance burning-proof, end-of-line (Continuation)								
	BE/HR	80 - 100 3" - 4"	IIA, IIB3	D C	ATEX		X	
	BE/HR-E	80 - 100 3" - 4"	IIB1	-	ATEX		X	82 - 83
	BE/HR-E	80 - 100 3" - 4"	IIB3, IIB	C B	ATEX IMO		X	
	BE/HR 400	150 - 200 6" - 8"	IIA	D	ATEX		X	
	LH/EB	150 - 400 6" - 16"	IIA1 (I)	-	ATEX			
Vent caps, end-of-line, without flame arrester unit								
	EH/0	20 - 80 ¾" - 3"						
	EH/0S	100 - 600 4" - 24"						
	E/KS	50 - 200 2" - 8"						



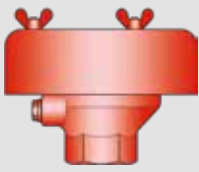

Deflagration Flame Arrester, End-of-Line

PROTEGO® BE/AD

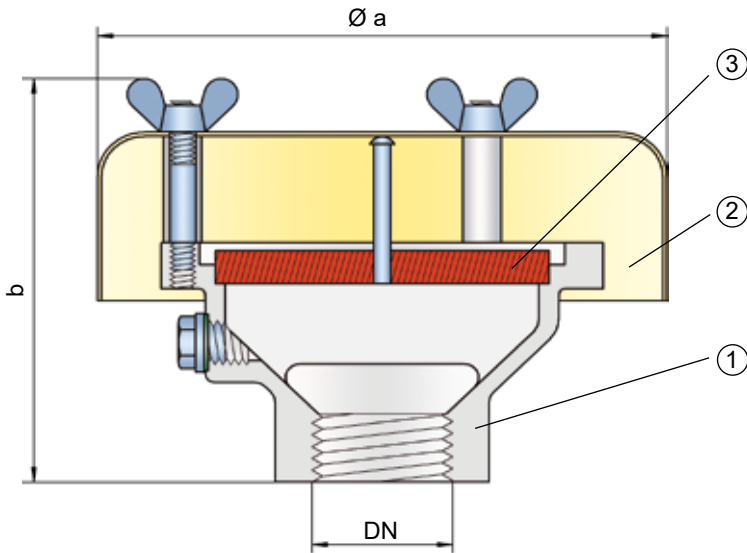

Function and Description

The PROTEGO® BE/AD end-of-line deflagration flame arrester provides protection against atmospheric deflagrations. The device is usually installed on vent lines of small vessels and plant equipment which are not pressurized. For safe application, it is important that an endurance burning situation can be excluded. So typically, it is installed on vents lines which discharge vapor for a short time period. The device is the ideal solution for preventing flame transmission from atmospheric deflagration into the vessel or plant.

The PROTEGO® BE/AD consists of the housing (1), a weather hood (2), and the PROTEGO® flame arrester unit (3). The device is equipped with a metal weather hood. The FLAMEFILTER® gap size will depend on the device's intended use. Specifying the operating conditions, such as the temperature, pressure, explosion group, and the composition of the fluid, enables PROTEGO® to select the best end-of-line deflagration flame arrester for your application. The PROTEGO® BE/AD series end-of-line deflagration flame arrester is available for substances from explosion groups IIA to IIC (NEC groups D to B).

The standard design can be used with an operating temperature of up to +60°C / 140°F.

EU conformity according to the currently valid ATEX directive. Approvals according to other national/international regulations on request.

Special Features and Advantages

- Weather hood provides protection against environmental impact (harsh weather conditions, foreign bodies, and nesting animals.)
- easy maintenance
- quick removal and installation of FLAMEFILTER®
- threaded connection
- provides protection against atmospheric deflagrations
- low operating and lifecycle costs
- cost-effective Flame arrester
- cost-effective spare parts

Design Type and Specification

Deflagration flame arrester, end-of-line, basic design **BE/AD**

Special designs available upon request.

Table 1: Dimensions

Dimensions in mm / inches

To select the nominal size (DN), please use the flow capacity charts on the following pages.

DN	15 / G ½"	20 / G ¾"	25 / G 1"	32 / G 1¼"	40 / G 1½"	50 / G 2"
a	116 / 4.57	116 / 4.57	116 / 4.57	116 / 4.57	200 / 7.87	200 / 7.87
b	80 / 3.15	80 / 3.15	85 / 3.35	85 / 3.35	150 / 5.91	150 / 5.91

Table 2: Selection of explosion group

MESG	Expl. Gr. (IEC/CEN)	Gas Group (NEC)	
≥ 0,65 mm	IIB3	C	Special approvals upon request.
< 0,5 mm	IIC	B	

Table 3: Specification of max. operating temperature

≤ 60°C / 140°F	Tmaximum allowable operating temperature in °C	
-	Designation	Higher operating temperatures upon request.

Table 4: Material selection

Design	B	C	
Housing	Stainless Steel	Hastelloy	Special materials upon request.
Weather hood	Stainless Steel	Stainless Steel	
FLAMEFILTER®	Stainless Steel	Hastelloy	

Table 5: Type of connection

Pipe thread DIN ISO 228-1	DIN	Other types of thread upon request.
---------------------------	-----	-------------------------------------



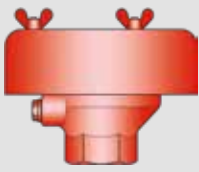

Deflagration Flame Arrester, End-of-Line

Flow Capacity Charts

PROTEGO® BE/AD

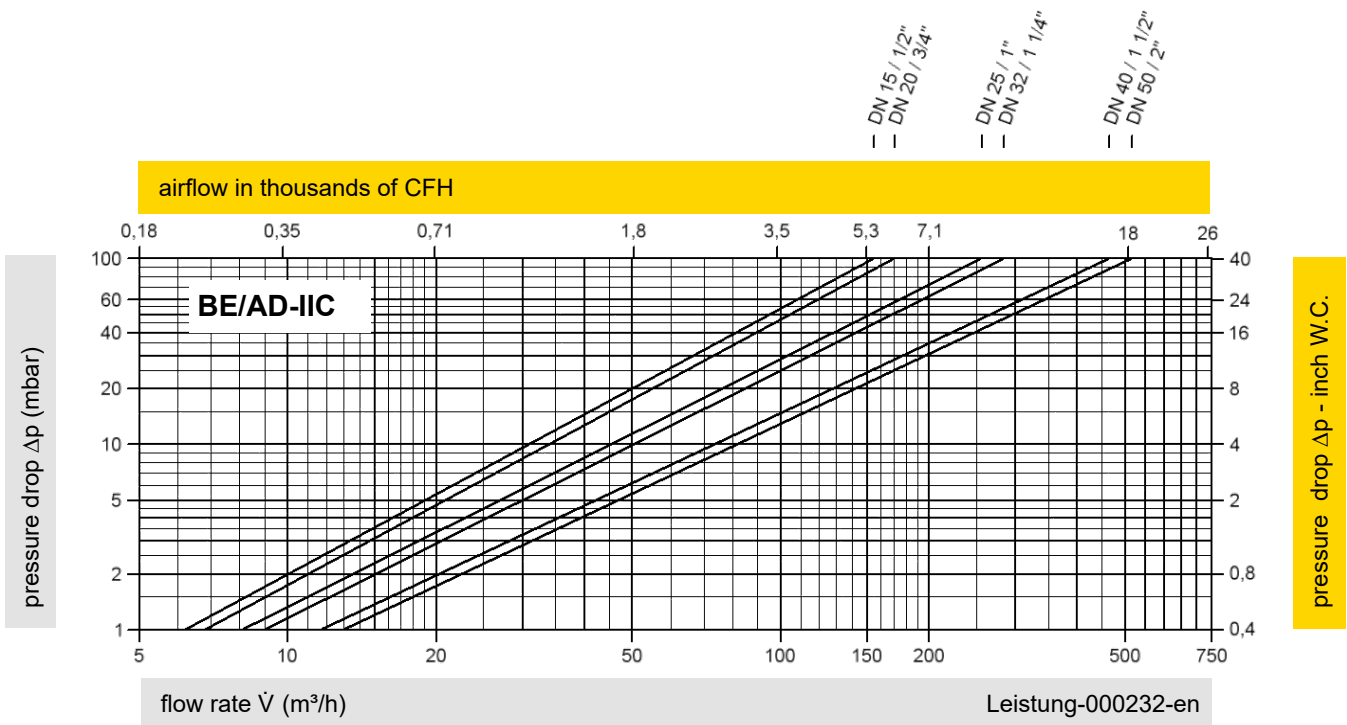
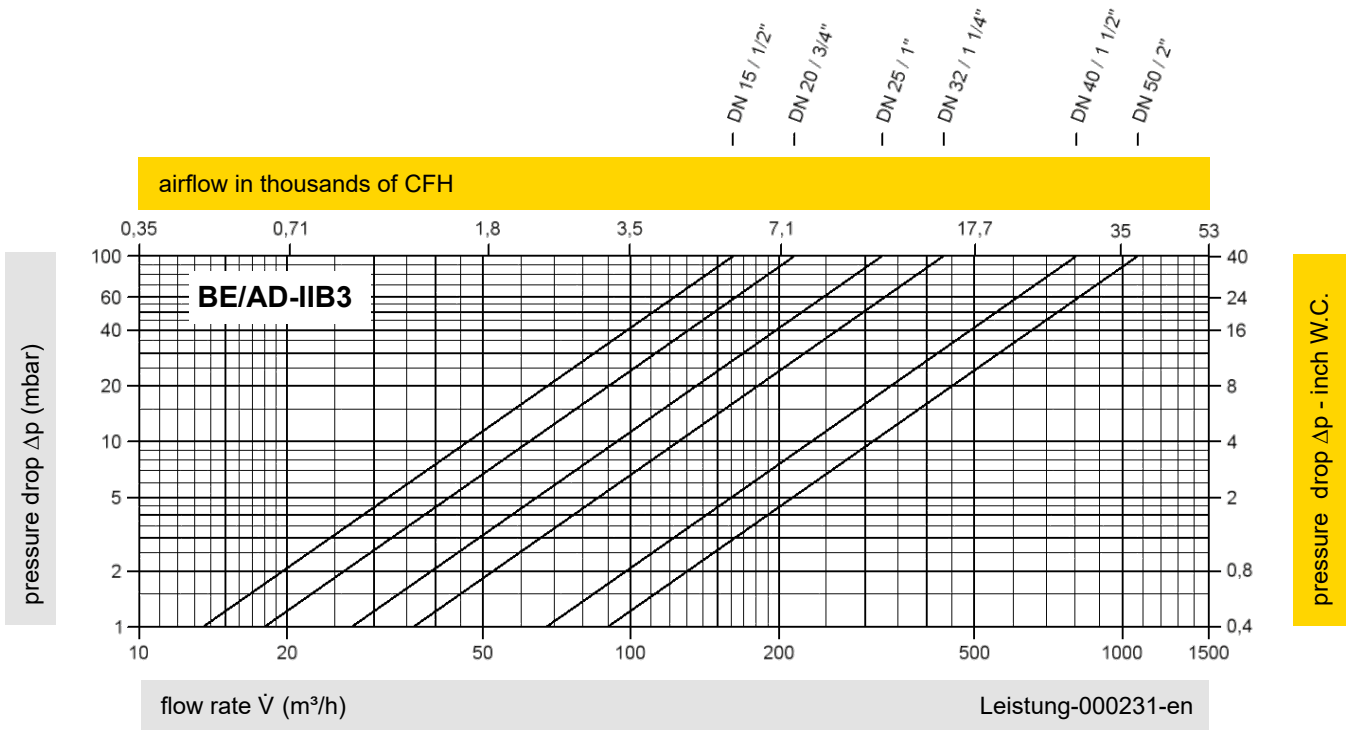

The flow capacity charts have been determined with a calibrated and TÜV certified flow capacity test rig. Volume flow \dot{V} in (m³/h) and CFH refer to the standard reference conditions of air in ISO 6358 (20°C, 1bar). For conversion to other densities and temperatures, refer to Sec. 1: "Technical Fundamentals."



Deflagration Flame Arrester, End-of-Line



PROTEGO® LH/AD

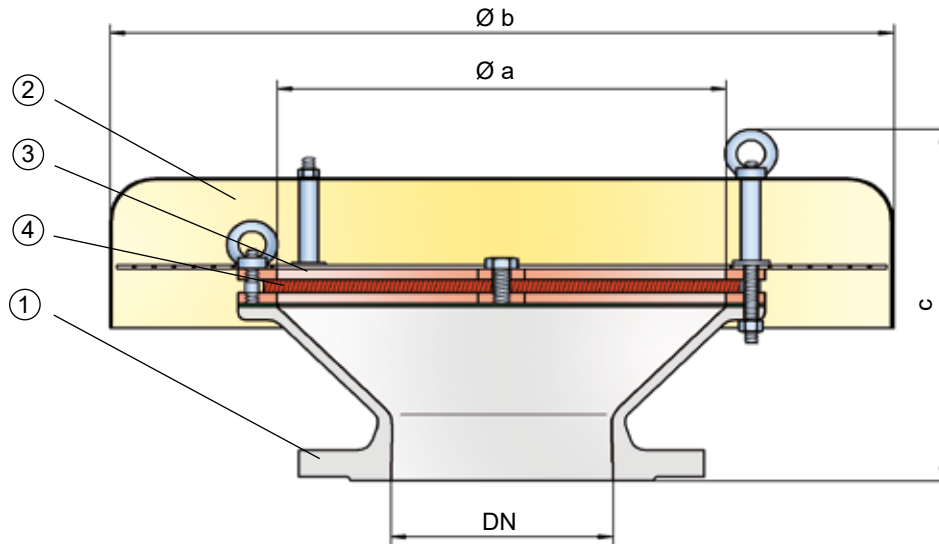

Function and Description

The PROTEGO® LH/AD end-of-line deflagration flame arrester provides protection against flame transmission through atmospheric deflagration. The device is typically installed on vent lines of vessels and plant equipment which are not pressurized. For safe application, it is important that an endurance burning situation can be excluded. So typically, it is installed on vent lines which discharge vapor for a short time period. The device prevents flame transmission from atmospheric deflagration into the vessel or plant.

The PROTEGO® LH/AD consists of the housing (1), a weather hood (2), and the PROTEGO® flame arrester unit (3). The device is equipped with a metal weather hood. A protection screen is installed between the weather hood and the housing to keep out animals and foreign bodies. The FLAMEFILTER® (4) gap size depends on the device's intended use. Specifying the operating conditions, such as the temperature, explosion group and the composition of the fluid, enables PROTEGO® to select the best end-of-line deflagration flame arrester for your application.

The PROTEGO® LH/AD series end-of-line deflagration flame arrester is available for substances from explosion groups IIA to IIC (NEC groups D to B). Special certifications for carbon disulfide are available.

The standard design can be used with an operating temperature of up to +60°C / 140°F. Devices with special approval for higher temperatures are available upon request.

EU conformity according to the currently valid ATEX directive. Approvals according to other national/international regulations on request.

Special Features and Advantages

- weather hood with protection screen protects the PROTEGO® flame arrester unit against environmental impact, such as nesting animals and weather conditions
- available for DN 50/2"- bis DN 800/32"- pipes
- trouble-free maintenance
- advanced design for higher operating temperatures
- provides protection against atmospheric deflagrations
- low operating and lifecycle costs
- cost-effective Flame arrester
- cost-effective spare parts

Design Type and Specification

End-of-line deflagration flame arrester, basic design

LH/AD

End-of-line deflagration flame arrester for carbon disulfide

LH/AD-CS2

Special designs available upon request.

Table 1: Dimensions

Dimensions in mm / inches

To select the nominal size (DN), please use the flow capacity charts on the following pages.

DN	a	b	IIB3	IIC
			c*	c*
50 / 2"	100 / 3.94	200 / 7.87	175 / 6.89	185 / 7.28
80 / 3"	150 / 5.91	240 / 9.45	180 / 7.09	195 / 7.68
100 / 4"	200 / 7.87	295 / 11.61	220 / 8.66	235 / 9.25
125 / 5"	250 / 9.84	350 / 13.78	240 / 9.45	-
150 / 6"	300 / 11.81	550 / 21.65	260 / 10.24	270 / 10.63
200 / 8"	300 / 11.81	550 / 21.65	260 / 10.24	270 / 10.63
250 / 10"	400 / 15.75	600 / 23.62	355 / 13.98	365 / 14.37
300 / 12"	400 / 15.75	600 / 23.62	340 / 13.39	350 / 13.78
350 / 14"	600 / 23.62	800 / 31.50	390 / 15.35	400 / 15.75
400 / 16"	600 / 23.62	800 / 31.50	380 / 14.96	390 / 15.35
500 / 20"	700 / 27.56	1000 / 39.37	400 / 15.75	410 / 16.14
600 / 24"	800 / 31.50	1200 / 47.24	475 / 18.70	485 / 19.09
700 / 28"	1000 / 39.37	1400 / 55.12	505 / 19.88	515 / 20.28
800 / 32"	1200 / 47.24	1600 / 62.99	550 / 21.65	560 / 22.05

* "c" is reference values. Exact measures depend on the flange connection.

Table 2: Selection of explosion group

MESG	Expl. Gr. (IEC/CEN)	Gas Group (NEC)	
≥ 0,65 mm	IIB3	C	Special approvals upon request.
< 0,5 mm	IIC	B	

Table 3: Specification of max. operating temperature

≤ 60°C / 140°F	Tmaximum allowable operating temperature in °C	
-	Classification	Higher operating temperatures upon request.

Table 4: Material selection for housing

Design	A	B	
Housing	Steel	Stainless Steel	Special materials upon request.
Weather hood	Stainless Steel	Stainless Steel	
Protection screen	Stainless Steel	Stainless Steel	
Flame arrester unit	A, B	B	

Table 5: Material combinations of flame arrester unit

Design	A	B	
FLAMEFILTER® casing	Steel	Stainless Steel	Special materials upon request.
FLAMEFILTER®	Stainless Steel	Stainless Steel	

Table 6: Flange connection type

EN 1092-1; Form B1	Other types upon request.
ASME B16.5 CL 150 R.F.	



for safety and environment



Deflagration Flame Arrester, End-of-Line

Flow Capacity Charts

PROTEGO® LH/AD

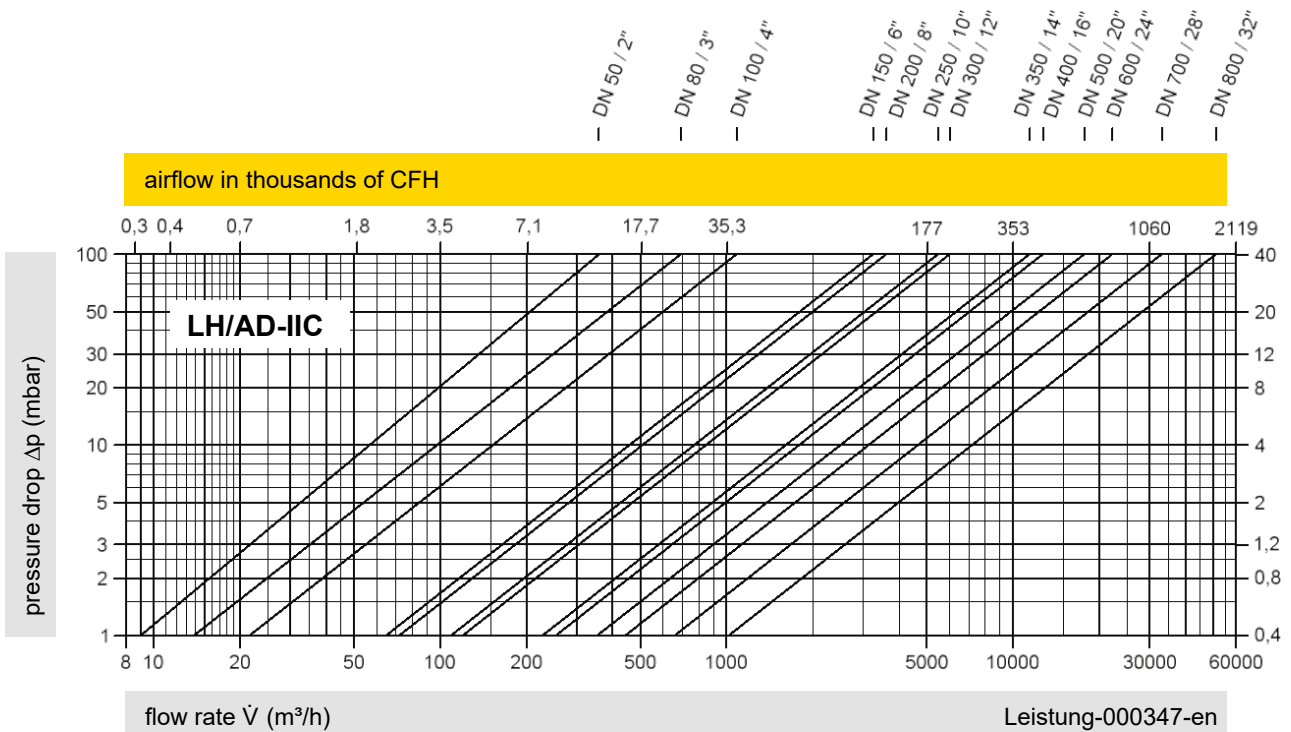
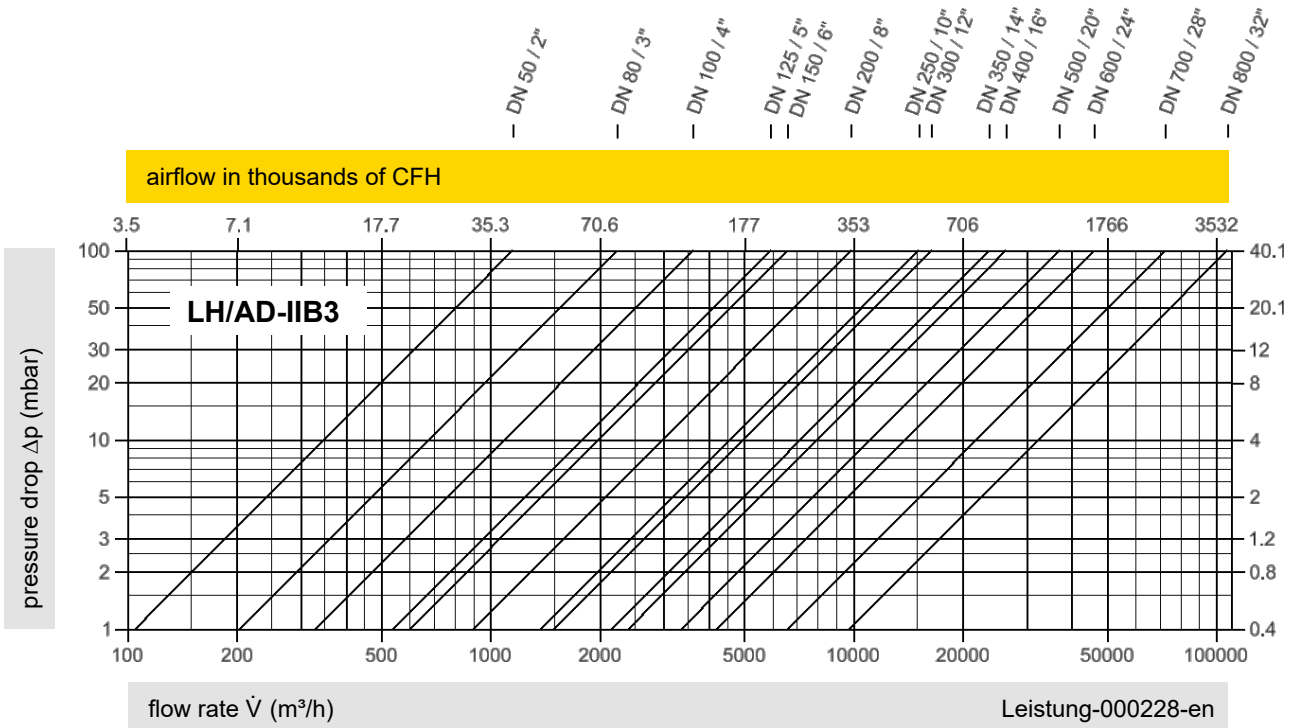

The flow capacity charts have been determined with a calibrated and TÜV certified flow capacity test rig. Volume flow \dot{V} in (m³/h) and CFH refer to the standard reference conditions of air in ISO 6358 (20°C, 1bar). For conversion to other densities and temperatures, refer to Sec. 1: "Technical Fundamentals."

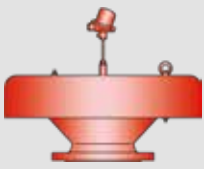

Deflagration Flame Arrester- Short-time burning-proof, End-of-Line

PROTEGO® LH/AD-T

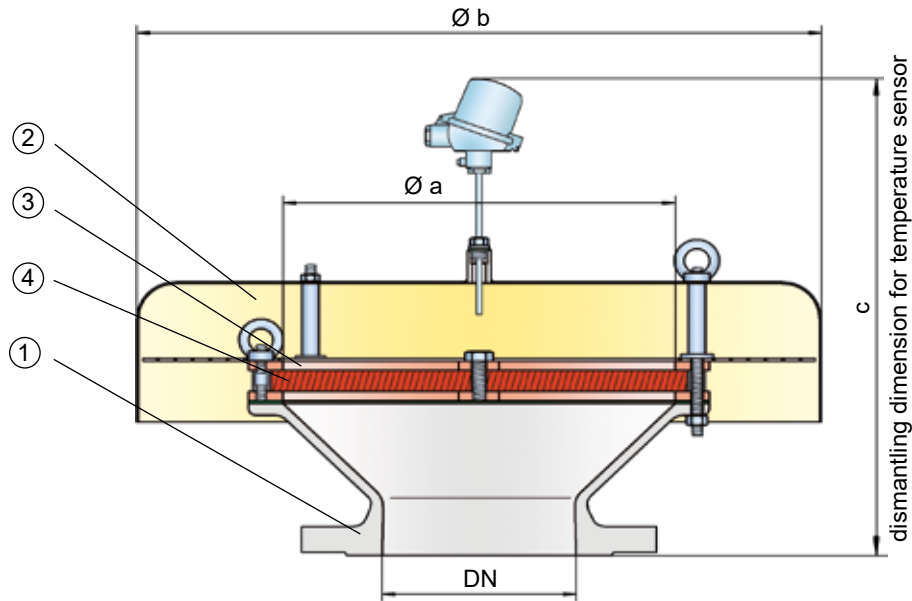

Function and Description

The PROTEGO® LH/AD-T end-of-line deflagration flame arrester provides protection against flame transmission through atmospheric deflagration and short time burning on the flame arrester element. The device is typically installed on vent lines of vessels and plant equipment which are not pressurized. The device is equipped with a temperature sensor which immediately detects a flame on the FLAMEFILTER® surface. After the flame is detected, a secondary measure, such as inerting or closing of a shut-off valve to block the vapor flow to the device, should activate within 60 seconds and extinguish the flame so that the system can operate safely. The device prevents flame transmission from short time burning and atmospheric deflagration into the vessel or plant.

The PROTEGO® LH/AD-T consists of the housing (1), a weather hood (2), and the PROTEGO® flame arrester unit (3). The device is equipped with a metal weather hood. The FLAMEFILTER® (4) gap size depends on the device's intended use. Specifying the operating conditions, such as the temperature, explosion group, and the composition of the fluid, enables PROTEGO® to select the best end-of-line deflagration flame arrester for your application. The PROTEGO® LH/AD-T series end-of-line deflagration flame arrester is available for substances from explosion groups IIA to IIC (NEC groups D to B).

The standard design can be used with an operating temperature of up to +60°C / 140°F. Devices with special approval for higher temperatures are available upon request.

EU conformity according to the currently valid ATEX directive. Approvals according to other national/international regulations on request.

Special Features and Advantages

- weather hood with protection screen protects the PROTEGO® flame arrester unit against environmental impact, such as nesting animals and weather conditions
- available for DN 50/2"- bis DN 800/32"- pipes
- trouble-free maintenance
- advanced design for higher operating temperatures
- provides protection against atmospheric deflagrations and short-time burning
- low operating and lifecycle costs
- cost-effective Flame arrester
- cost effective spare parts

Design Type and Specification

End-of-line deflagration flame arrester, basic design **LH/AD-T**

Special designs available upon request.

Table 1: Dimensions

Dimensions in mm / inches

To select the nominal size (DN), please use the flow capacity charts on the following pages.

DN	a	b	IIB3	IIC
			c*	c*
50 / 2"	100 / 3.94	240 / 9.45	530 / 20.87	550 / 21.65
80 / 3"	150 / 5.91	295 / 11.61	560 / 22.05	580 / 22.83
100 / 4"	200 / 7.87	350 / 13.78	585 / 23.03	605 / 23.82
150 / 6"	300 / 11.81	600 / 23.62	630 / 24.80	655 / 25.79
200 / 8"	300 / 11.81	600 / 23.62	630 / 24.80	655 / 25.79
250 / 10"	400 / 15.75	800 / 31.50	750 / 29.53	770 / 30.31
300 / 12"	400 / 15.75	800 / 31.50	740 / 29.13	760 / 29.92
350 / 14"	600 / 23.62	1000 / 39.37	800 / 31.50	820 / 32.28
400 / 16"	600 / 23.62	1000 / 39.37	790 / 31.10	815 / 32.09
500 / 20"	700 / 27.56	1200 / 47.24	810 / 31.89	835 / 32.87
600 / 24"	800 / 31.50	1200 / 47.24	935 / 36.81	960 / 37.80
700 / 28"	1000 / 39.37	1500 / 59.06	975 / 38.39	995 / 39.17
800 / 32"	1200 / 47.24	1700 / 66.93	1015 / 39.96	1035 / 40.75

* 'c' is reference values. Exact measures depend on the flange connection.

Table 2: Selection of explosion group

MESG	Expl. Gr. (IEC/CEN)	Gas Group (NEC)	
≥ 0,65 mm	IIB3	C	Special approvals upon request.
< 0,5 mm	IIC	B	

Table 3: Specification of max. operating temperature

≤ 60°C / 140°F	Tmaximum allowable operating temperature in °C	
-	Classification	Higher operating temperatures upon request.

Table 4: Material selection for housing

Design	A	B	
Housing	Steel	Stainless Steel	Special materials upon request.
Weather hood	Stainless Steel	Stainless Steel	
Protection screen	Stainless Steel	Stainless Steel	
Flame arrester unit	A, B	B	

Table 5: Material combinations of flame arrester unit

Design	A	B	
FLAMEFILTER® casing	Steel	Stainless Steel	Special materials upon request.
FLAMEFILTER®	Stainless Steel	Stainless Steel	

Table 6: Flange connection type

EN 1092-1; Form B1	Other types upon request.
ASME B16.5 CL 150 R.F.	



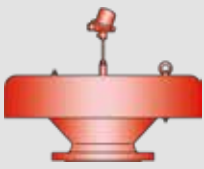

Deflagration Flame Arrester- Short-time burning-proof, End-of-Line

Flow Capacity Charts

PROTEGO® LH/AD-T

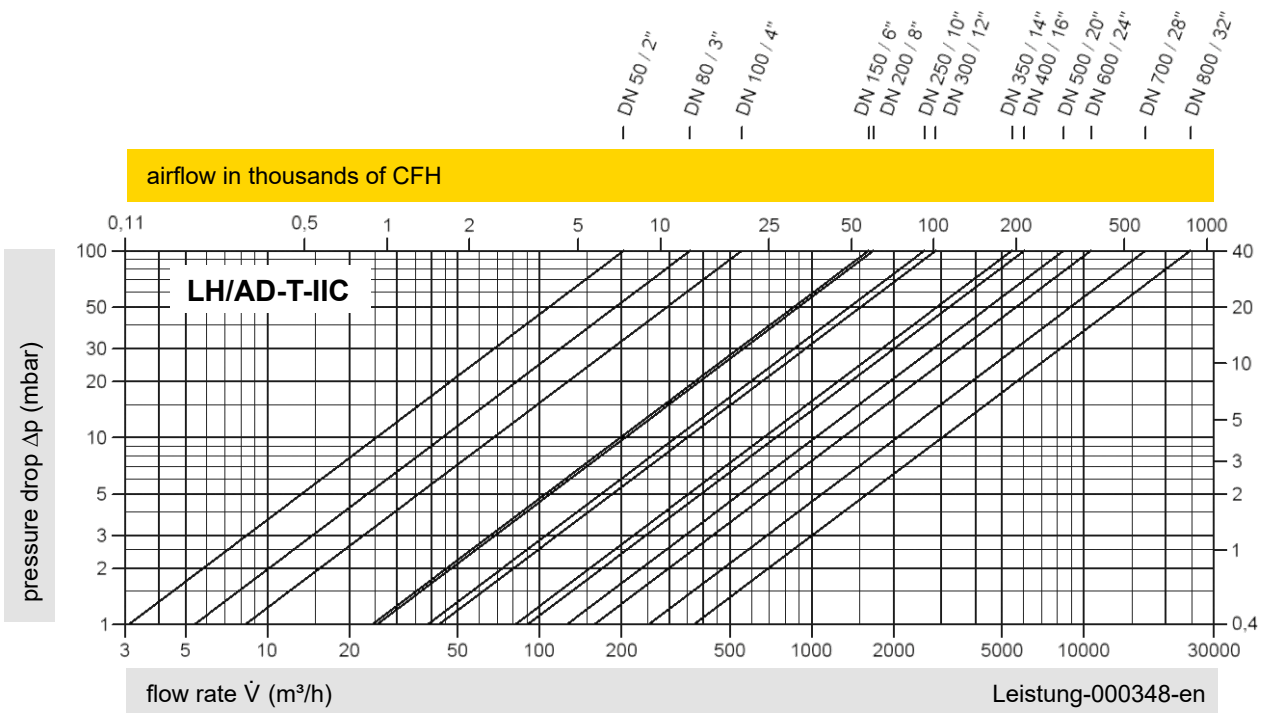
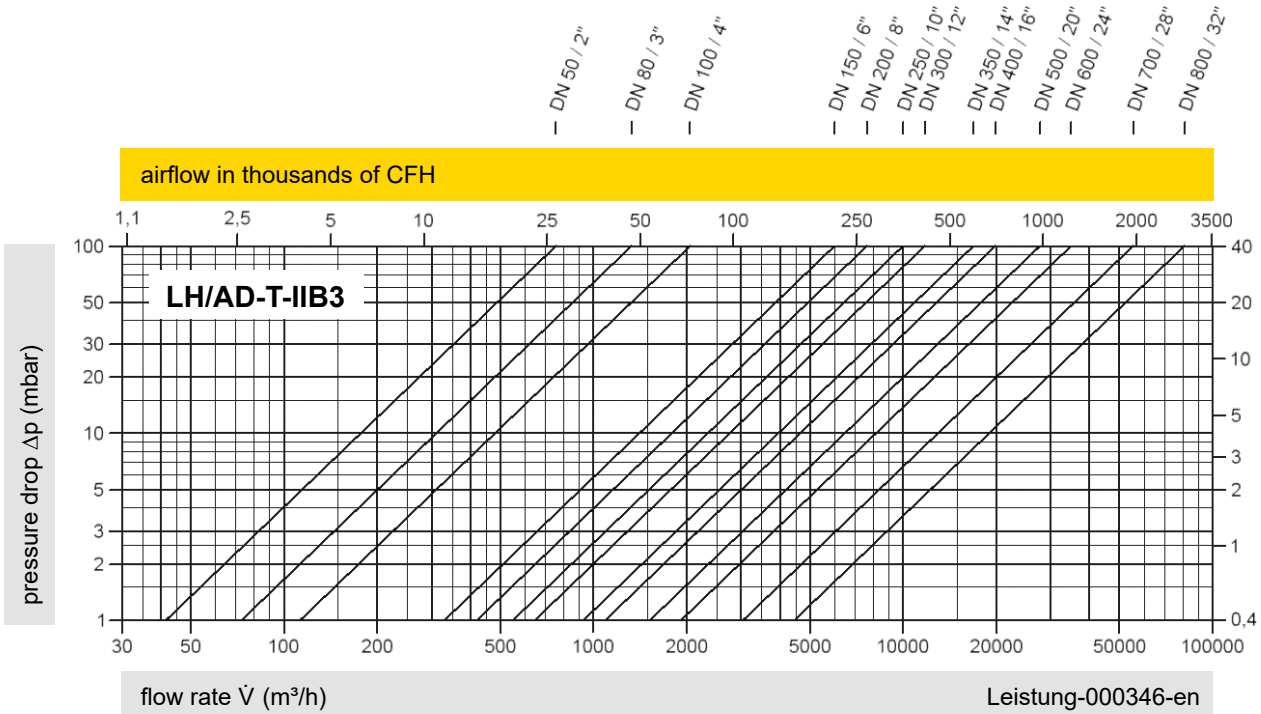

The flow capacity charts have been determined with a calibrated and TÜV certified flow capacity test rig. Volume flow \dot{V} in (m³/h) and CFH refer to the standard reference conditions of air in ISO 6358 (20°C, 1bar). For conversion to other densities and temperatures, refer to Sec. 1: "Technical Fundamentals."



PROTEGO® EB-IIA and IIB

DN 25 - 150 / 1" - 6"

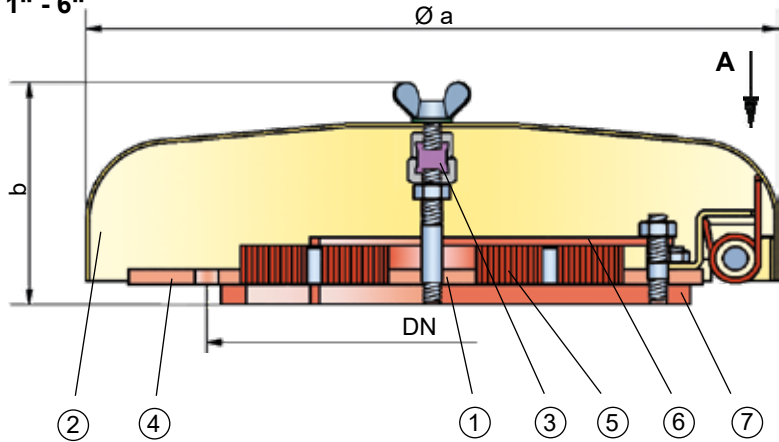

View A

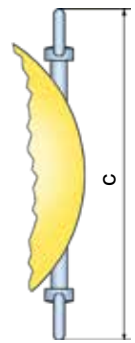

DN 200 - 800 / 8" - 32"

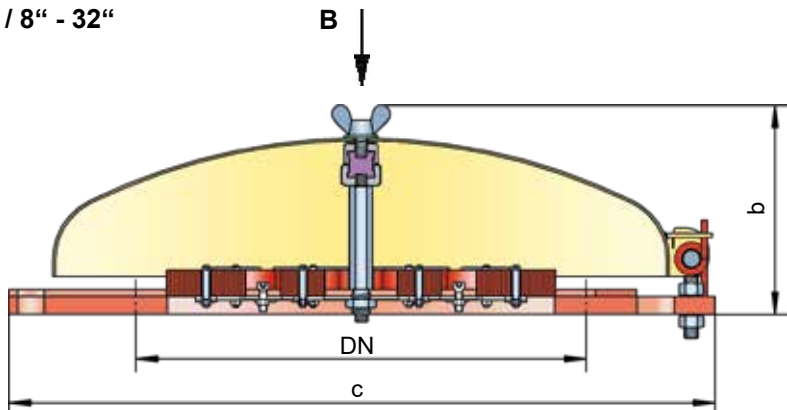

View B

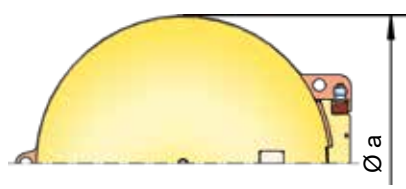

DN 25 - 150 / 1" - 6"

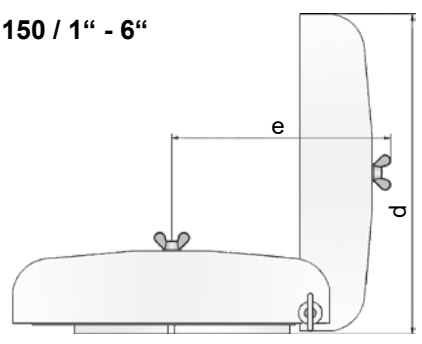

DN 200 - 800 / 8" - 32"

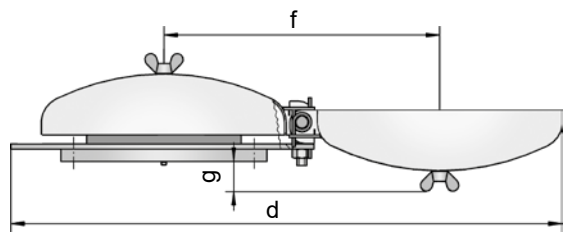

EB with cone (example)

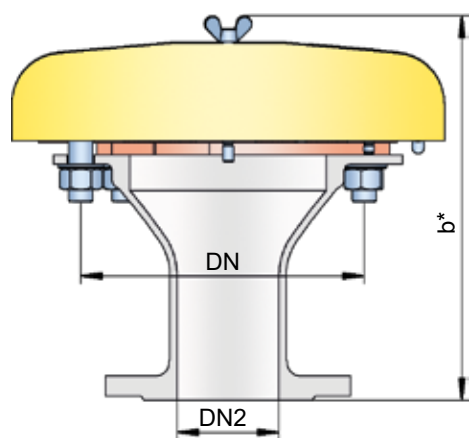

EB with nozzle (example)

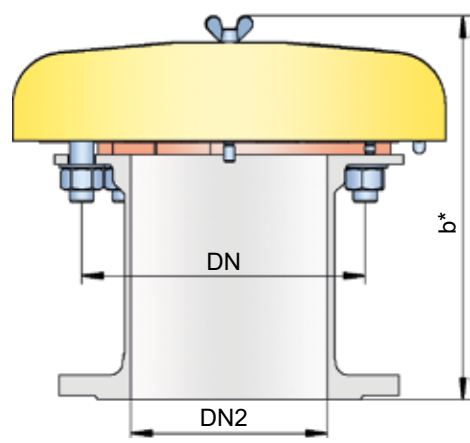



PROTEGO® EB
(Flyer pdf)



Demonstration of endurance burning
Video

Function and Description

The PROTEGO® EB end-of-line deflagration flame arrester provides protection against atmospheric deflagration and long-lasting stabilized flames, called endurance burning. The device is typically installed on vent lines of vessels and plant equipment which is not pressurized. The device prevents flame transmission from endurance burning or atmospheric deflagration into the vessel or plant.

The PROTEGO® EB-IIA consists of the PROTEGO® flame arrester unit (1) and the metal weather hood (2). During normal operation, the metal weather hood is in a closed position. If a stabilized flame burns on the flame arrester element surface, the melting element (3), located in a center position, will melt and let the spring-loaded weather hood move into the open position. The PROTEGO® flame arrester unit consists of one or more FLAMEFILTER® (5), which are installed in a FLAMEFILTER® casing (4), a fixation element (6) and an insert ring (7). The FLAMEFILTER® gap size, height, and quantity depend on the device's intended use.

The PROTEGO® EB series end-of-line deflagration flame arrester is available for substances from explosion group IIA and IIB (NEC group D and B).

The standard design can be used with an operating temperature of up to +60°C / 140°F. Devices with special approval for higher temperatures are available upon request.

EU conformity according to the currently valid ATEX directive. Approvals according to other national/international regulations on request.

Special Features and Advantages

- weather hood protects the PROTEGO® flame arrester unit against environmental impact, such as nesting animals and weather conditions
- in case of fire, the weather hood opens, allowing the flame to be seen from a far distance
- provides protection against atmospheric deflagrations and endurance burning of pure hydrocarbons
- centrally aligned melting element is resistant to chemicals
- modular design enables replacement of individual FLAMEFILTER® discs
- easy maintenance without disassembling of the FLAMEFILTER®
- cost-effective spare parts

Design Types and Specifications

End-of-line deflagration flame arrester, basic design	EB
End-of-line deflagration flame arrester, with cone	EB - DN/DN2
End-of-line deflagration flame arrester, with cone and heating jacket	EB - H - DN/DN2
Special designs available upon request.	

Table 1: Dimensions DN 25 - 150 / 1" - 6"
EB-IIA and EB-IIB

Dimensions in mm / inches

To select the nominal size (DN), please use the flow capacity chart on the following page.

DN	25 / 1"	32 / 1¼"	40 / 1½"	50 / 2"	65 / 2½"	80 / 3"	100 / 4"	125 / 5"	150 / 6"
a	218 / 8.58	218 / 8.58	218 / 8.58	218 / 8.58	218 / 8.58	353 / 13.90	353 / 13.90	353 / 13.90	353 / 13.90
b	113 / 4.45	113 / 4.45	113 / 4.45	113 / 4.45	113 / 4.45	113 / 4.45	113 / 4.45	113 / 4.45	113 / 4.45
c	232 / 9.13	232 / 9.13	232 / 9.13	232 / 9.13	232 / 9.13	306 / 12.05	306 / 12.05	306 / 12.05	306 / 12.05
d	222 / 8.74	222 / 8.74	222 / 8.74	222 / 8.74	222 / 8.74	355 / 13.98	355 / 13.98	355 / 13.98	355 / 13.98
e	217 / 8.54	217 / 8.54	217 / 8.54	217 / 8.54	217 / 8.54	322 / 12.68	322 / 12.68	322 / 12.68	322 / 12.68
EB-IIA und IIB with cone/nozzle**									
DN				50 / 2"		80 / 3"	100 / 4"		150 / 6"
DN2				≤ 50 / 2"		≤ 80 / 3"	≤ 100 / 4"		≤ 150 / 6"
b*				238 / 9.37		263 / 10.35	383 / 15.08		313 / 12.32

Dimensions DN 200 - 800 / 8" - 32"
EB-IIA

DN	200 / 8"	300 / 12"	400 / 16"	500 / 20"	600 / 24"	800 / 32"
a	405 / 15.94	555 / 21.85	705 / 27.75	855 / 33.66	1005 / 39.57	1210 / 47.64
b	177 / 6.97	206 / 8.11	235 / 9.25	265 / 10.43	294 / 11.57	330 / 12.99
c	496 / 19.53	650 / 25.59	802 / 31.57	987 / 38.86	1137 / 44.76	1336 / 52.60
d	900 / 35.43	1200 / 47.24	1500 / 59.06	1820 / 71.65	2120 / 83.46	2525 / 99.41
f	450 / 17.72	600 / 23.62	750 / 29.53	920 / 36.22	1070 / 42.13	1270 / 50.00
g	51 / 2.01	80 / 3.15	109 / 4.29	138 / 5.43	167 / 6.57	204 / 8.03
EB-IIA with cone/nozzle**						
DN	200 / 8"	300 / 12"	400 / 16"	500 / 20"	600 / 24"	800 / 32"
DN2	≤ 200 / 8"	≤ 300 / 12"	≤ 400 / 16"	≤ 500 / 20"	≤ 600 / 24"	≤ 800 / 32"
b*	401 / 15.94	456 / 17.95	535 / 21.06	614 / 24.17	693 / 27.28	830 / 32.68

** For combinations (DN/DN2), please use the table on the following page.



for safety and environment



Deflagration Flame Arrester- Endurance burning-proof, End-of-Line

PROTEGO® EB-IIA and IIB

Table 2: Combination (DN/DN2) for EB with cone

Remarks: Flow capacity charts for EB-DN/DN2-IIA/IIB with cone upon request.

DN	50/2"	80/3"	100/4"	150/6"	200/8"	300/12"	400/16"	500/20"	600/24"	800/32"
DN2										
20/¾"	IIA/IIB	IIA/IIB	IIA/IIB	IIA/IIB						
25/1"	IIA/IIB	IIA/IIB	IIA/IIB	IIA/IIB						
32/1¼"	IIA/IIB	IIA/IIB	IIA/IIB	IIA/IIB						
40/1½"	IIA/IIB	IIA/IIB	IIA/IIB	IIA/IIB						
50/2"	IIA/IIB	IIA/IIB	IIA/IIB	IIA/IIB	IIA					
65/2½"		IIA/IIB	IIA/IIB	IIA/IIB						
80/3"		IIA/ IIB	IIA/ IIB	IIA/ IIB	IIA	IIA				
100/4"			IIA/ IIB	IIA/ IIB	IIA	IIA				
125/5"				IIA/ IIB	IIA					
150/6"				IIA/ IIB	IIA	IIA	IIA			
200/8"					IIA	IIA	IIA	IIA	IIA	
250/10"						IIA	IIA	IIA		
300/12"							IIA	IIA	IIA	
350/14"								IIA	IIA	
400/16"								IIA	IIA	IIA
450/18"								IIA	IIA	IIA
500/20"									IIA	IIA
600/24"										IIA
700/28"										IIA

Table 3: Selection of explosion group

MESG	Expl. Gr. (IEC/CEN)	Gas Group (NEC)	Special approvals upon request.
> 0,90 mm	IIA	D	
≥ 0,50 mm	IIB	B	

Table 4: Specification of max. operating temperature

≤ 60°C / 140°F	Tmaximum allowable operating temperature in °C	Higher operating temperatures upon request.
-	Classification	

Table 5: Material selection for housing

Design	A	B	Special materials upon request.
Flange ring	Steel	Stainless Steel	
Weather hood	Steel	Stainless Steel	
Cone/nozzle	Steel	Stainless Steel	
Flame arrester unit	A, B, C	B, C	

Table 6: Material combinations of flame arrester unit

Design	A	B	C	Special materials upon request.
FLAMEFILTER® casing	Steel	Stainless Steel	Stainless Steel/Hastelloy	
FLAMEFILTER®	Stainless Steel	Stainless Steel	Hastelloy	
Insert ring/safety bar	Stainless Steel	Stainless Steel	Stainless Steel/Hastelloy	

Table 7: Flange connection type

EN 1092-1 (without cone); EN 1092-1; Form B1 (with cone/nozzle)	Other types upon request.
ASME B16.5 (without cone); ASME B16.5 CL 150 R.F. (with cone/nozzle)	

PROTEGO® EB-IIA and IIB without cone

* use with nozzle (DN=DN2)

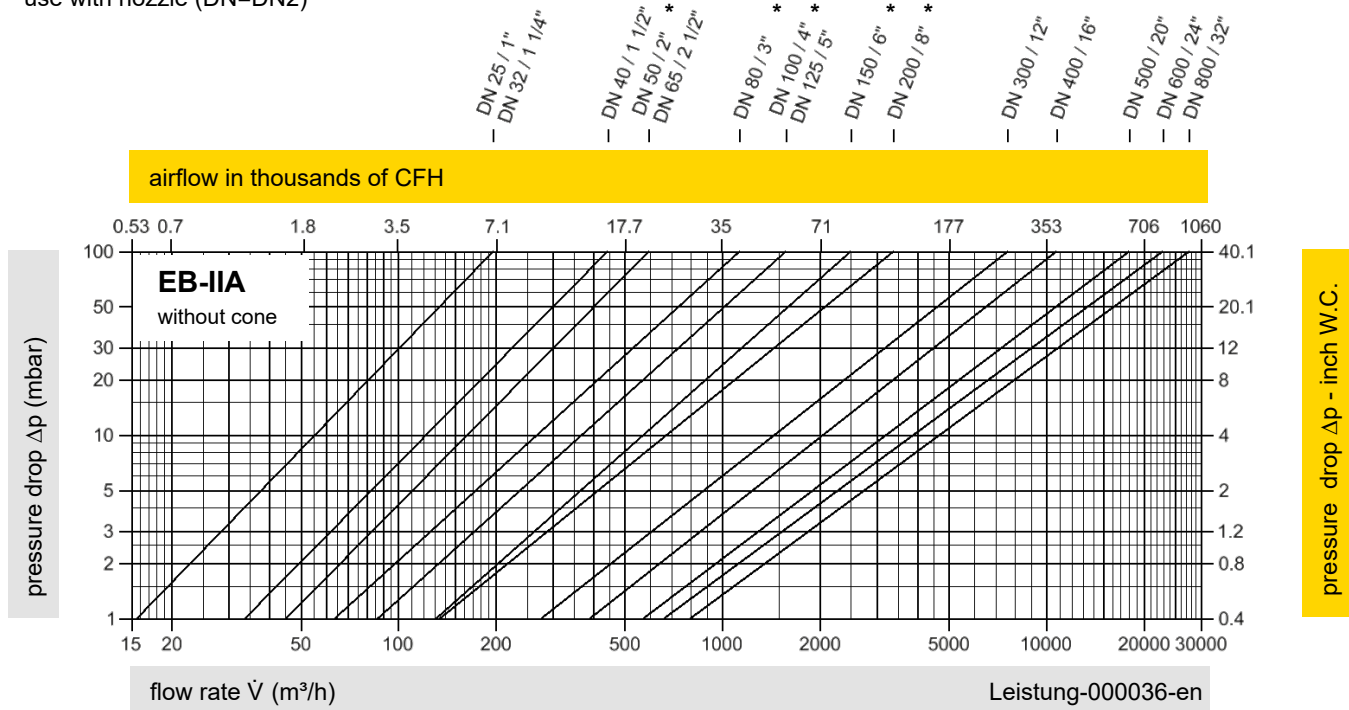

Remark: Flow capacity charts for EB-DN/DN2-IIA/IIB with cone upon request.

* use with nozzle (DN=DN2)

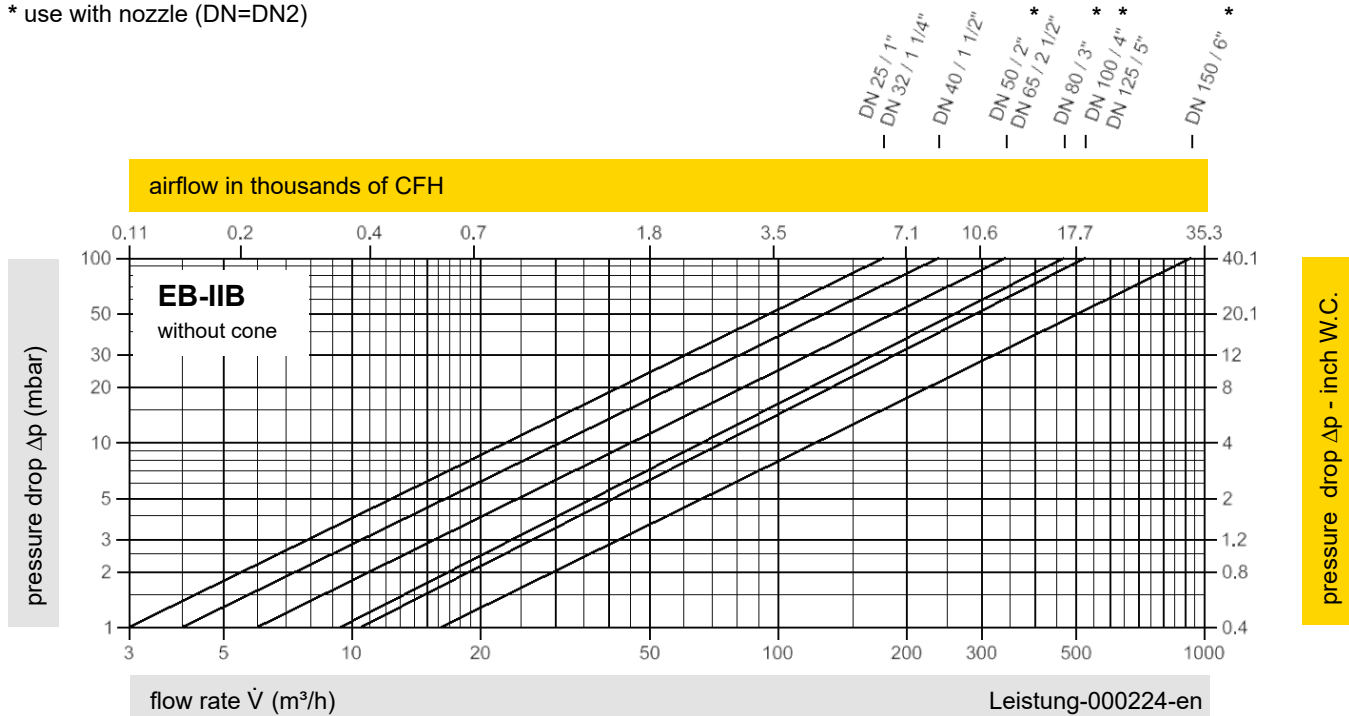

The flow capacity charts have been determined with a calibrated and TÜV certified flow capacity test rig. Volume flow \dot{V} in (m³/h) and CFH refer to the standard reference conditions of air in ISO 6358 (20°C, 1bar). For conversion to other densities and temperatures, refer to Sec. 1: "Technical Fundamentals."





Deflagration Flame Arrester- Endurance burning-proof, End-of-Line

PROTEGO® BE/HK-E

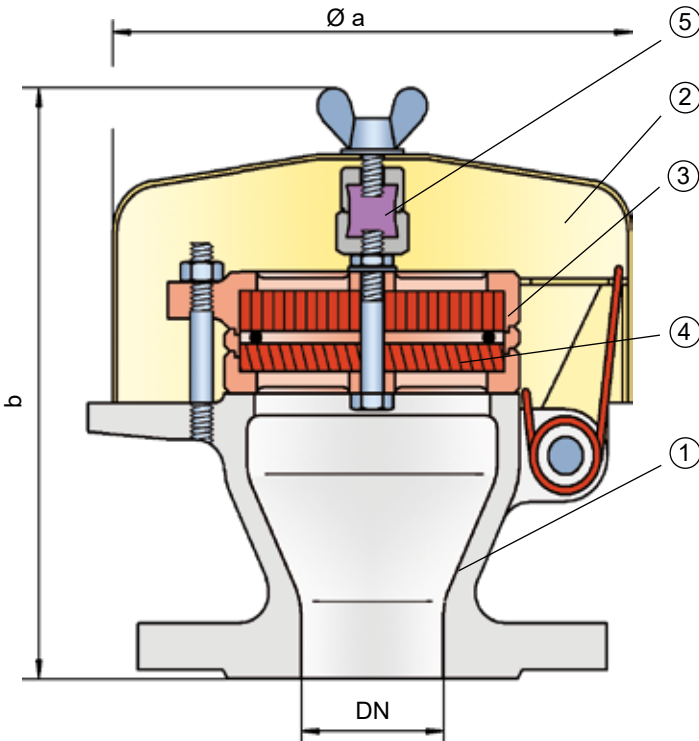

⑤ The standard design can be used for operating temperatures up to +60°C / 140°F.

② EU conformity according to the currently valid ATEX directive.
 ③ Approvals according to other national/international regulations on request.

Special Features and Advantages

- endurance burning protection for alcohols and hydrocarbons with MESG ≥ 0,85mm
- weather hood protects the PROTEGO® flame arrester unit against environmental impact, such as nesting animals and weather conditions
- in case of fire, the weather hood opens, allowing the flame to be seen from a far distance
- centrally aligned melting element is resistant to chemicals
- modular design enables replacement of individual FLAME-FILTER® discs
- trouble-free maintenance
- provides protection against atmospheric deflagrations and endurance burning
- cost-effective spare parts

Function and Description

The PROTEGO® BE/HK-E end-of-line deflagration flame arrester was specifically developed for vessels which are not pressurized and store Ethanol or other alcohols. The combustion of alcohol requires a modified flame arrester element design to provide protection against endurance burning. In addition, the device provides protection against atmospheric deflagration. It is typically installed on in - breathing and out-breathing vent lines to prevent flame transmission into the vessel or plant caused by endurance burning or atmospheric deflagration.

The PROTEGO® BE/HK-E consists of the housing (1), a weather hood (2), and the PROTEGO® flame arrester unit (3). During normal operation, the metal weather hood is in a closed position. If a stabilized flame burns on the flame arrester element surface, the melting element (5), located in a center position, will melt, and the spring-loaded weather hood will open. The PROTEGO® flame arrester unit consists of two FLAMEFILTER® discs (4) which are installed in a FLAMEFILTER® casing. The PROTEGO® BE/HK-E end-of-line deflagration flame arrester is available for alcohols and other substances with MESG ≥ 0,85mm.

Design Types and Specifications

There are two different designs:

End-of-line deflagration flame arrester, basic design **BE/HK-E - []**

End-of-line deflagration flame arrester with heating jacket **BE/HK-E - [H]**

Special designs available upon request.

Table 1: Dimensions

Dimensions in mm / inches

To select the nominal size (DN), please use the flow capacity charts on the following pages.

DN	20 / ¾"	25 / 1"	32 / 1¼"	40 / 1½"	50 / 2"	65 / 2½"	80 / 3"
a	163 / 6.42	163 / 6.42	163 / 6.42	183 / 7.20	183 / 7.20	218 / 8.58	218 / 8.58
b	180 / 7.09	177 / 6.97	177 / 6.97	190 / 7.48	190 / 7.48	200 / 7.87	200 / 7.87

Dimensions for deflagration flame arrester with heating jacket upon request.



Table 2: Selection of explosion group

MESG	Expl. Gr. (IEC/CEN)	Gas Group (NEC)	Special approvals upon request.
≥ 0,85 mm	IIB1	–	

Table 3: Material selection for housing

Design	B	C	Special materials upon request.
Housing	Steel	Stainless Steel	
Weather hood	Steel	Stainless Steel	
Flame arrester unit	A	A, B	

Table 4: Material combinations of flame arrester unit

Design	A	B	Special materials upon request.
FLAMEFILTER® casing	Stainless Steel	Stainless Steel	
FLAMEFILTER®	Stainless Steel	Hastelloy	
Spacer	Stainless Steel	Hastelloy	

Table 5: Flange connection type

EN 1092-1; Form B1	Other types upon request.
ASME B16.5 CL 150 R.F.	

Flow Capacity Chart

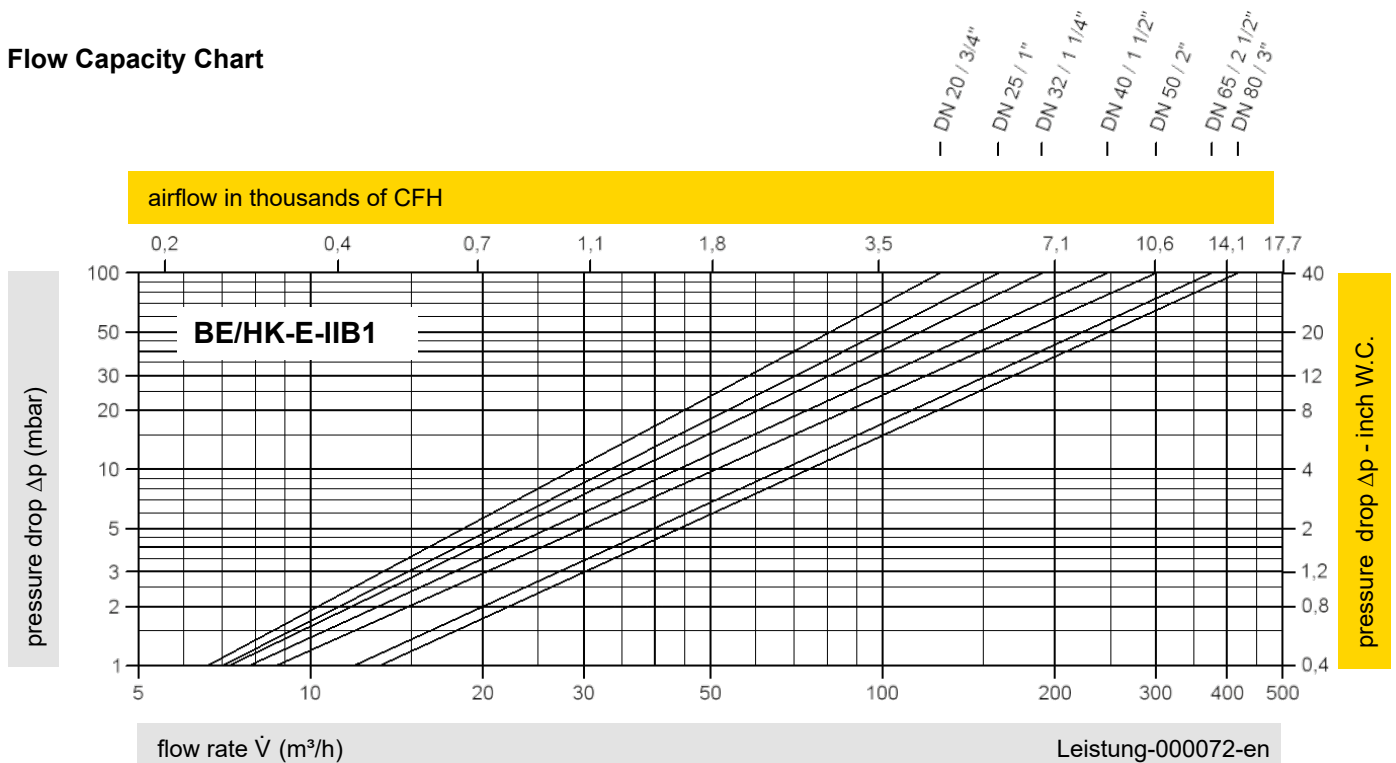

The flow capacity charts have been determined with a calibrated and TÜV certified flow capacity test rig. Volume flow \dot{V} in (m³/h) and CFH refer to the standard reference conditions of air in ISO 6358 (20°C, 1bar). For conversion to other densities and temperatures, refer to Sec. 1: "Technical Fundamentals."





Deflagration Flame Arrester- Endurance burning-proof, End-of-Line



PROTEGO® BE/HR-E

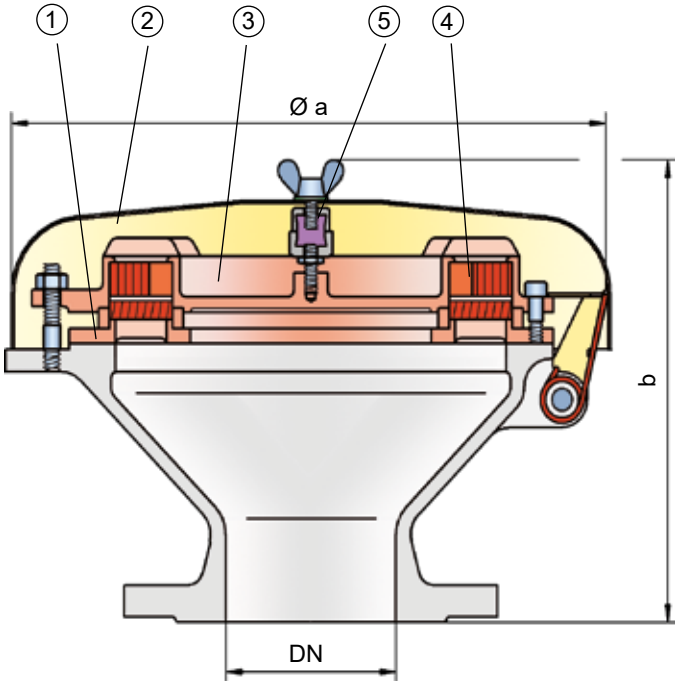

The PROTEGO® BE/HR-E end-of-line deflagration flame arrester is available for alcohols and other substances with a MESG $\geq 0,85$ mm.

The standard design can be used for operating temperatures up to $+60^{\circ}\text{C} / 140^{\circ}\text{F}$.

EU conformity according to the currently valid ATEX directive. Approvals according to other national/international regulations on request.

Special Features and Advantages

- endurance burning protection for alcohols and hydrocarbons with MESG $\geq 0,85\text{mm}$
- weather hood protects the PROTEGO® flame arrester unit against environmental impact, such as nesting animals and weather conditions
- in case of fire, the weather hood opens, allowing the flame to be seen from a far distance
- centrally aligned melting element is resistant to chemicals
- modular design enables replacement of individual FLAME-FILTER® discs
- trouble-free maintenance
- provides protection against atmospheric deflagrations and endurance burning
- cost-effective spare parts

Design Types and Specifications

There are two different designs:

End-of-line deflagration flame arrester, basic design BE/HR - E -

End-of-line deflagration flame arrester with heating jacket BE/HR - E -

Special designs available upon request.

Function and Description

The PROTEGO® BE/HR-E end-of-line deflagration flame arrester was specifically developed for vessels which are not pressurized and store Ethanol or other alcohols with a MESG $\geq 0,85$ mm. The combustion of alcohol requires a modified flame arrester element design to provide protection against endurance burning. In addition, the device provides protection against atmospheric deflagration. It is typically installed on in-breathing and out-breathing vent lines to prevent flame transmission into the vessel or plant caused by endurance burning or atmospheric deflagration.

The PROTEGO® BE/HR-E consists of the housing (1), a weather hood (2), and the PROTEGO® flame arrester unit (3). During normal operation, the metal weather hood is in a closed position. If a flame burns on the flame arrester element surface, the melting element (5), located in a center position, will melt, and the spring-loaded weather hood will open. The PROTEGO® flame arrester unit consists of two FLAMEFILTER® discs (4) which are installed in a FLAMEFILTER® casing.

Table 1: Dimensions

Dimensions in mm / inches

To select the nominal size (DN), please use the flow capacity charts on the following pages.

DN	80 / 3"	100 / 4"	Dimensions for deflagration flame arrester with heating jacket upon request.
a	353 / 13.90	353 / 13.90	
b	250 / 9.84	250 / 9.84	



Demonstration of endurance burning
Video

Table 2: Selection of explosion group

MESG	Expl. Gr. (IEC/CEN)	Gas Group (NEC)	
≥ 0,85 mm	IIB1	–	Special approvals upon request.

Table 3: Material selection for housing

Design	B	C	
Housing	Steel	Stainless Steel	Special materials upon request.
Weather hood	Steel	Stainless Steel	
Flame arrester unit	A	A, B	

Table 4: Material combinations of flame arrester unit

Design	A	B	
FLAMEFILTER® casing	Stainless Steel	Stainless Steel	Special materials upon request.
FLAMEFILTER®	Stainless Steel	Hastelloy	
Spacer	Stainless Steel	Hastelloy	

Table 5: Flange connection type

EN 1092-1; Form B1	Other types upon request.
ASME B16.5 CL 150 R.F.	

Flow Capacity Chart

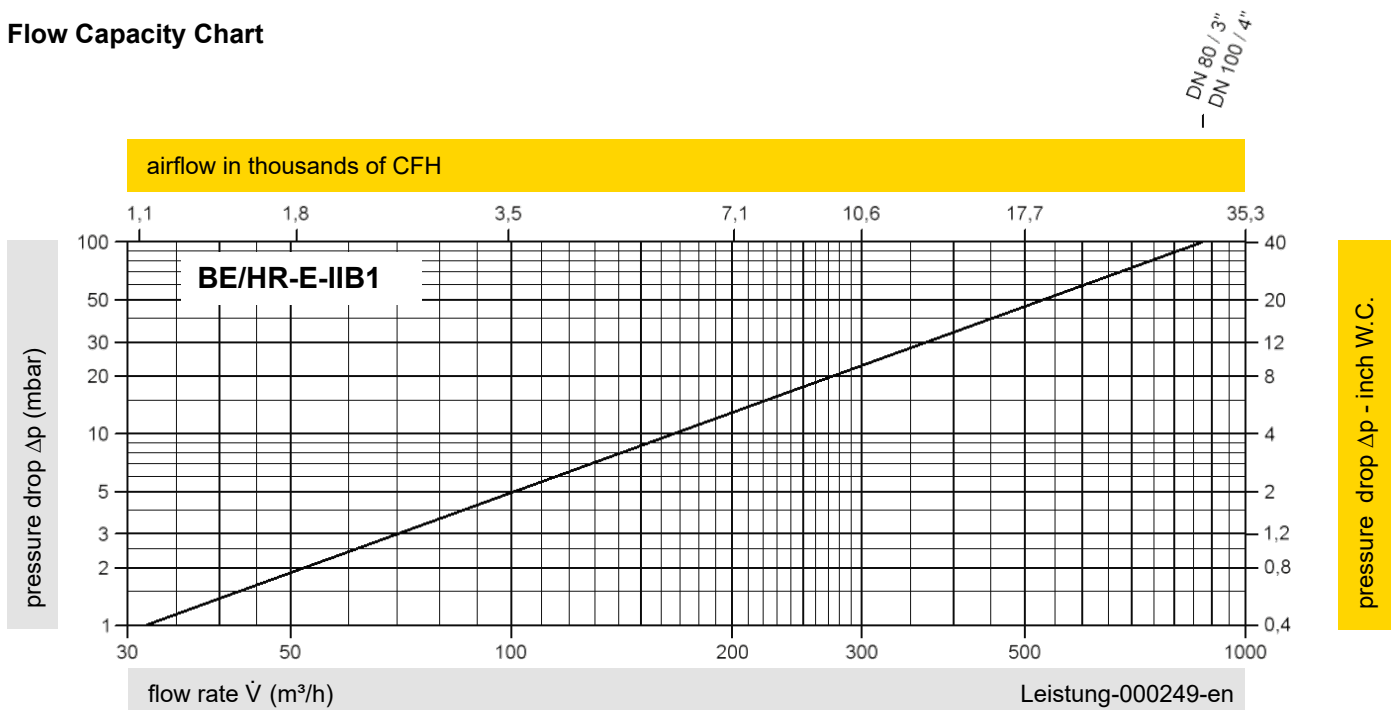

The flow capacity charts have been determined with a calibrated and TÜV certified flow capacity test rig. Volume flow \dot{V} in (m³/h) and CFH refer to the standard reference conditions of air in ISO 6358 (20°C, 1bar). For conversion to other densities and temperatures, refer to Sec. 1: "Technical Fundamentals."



www.protego.com



PROTEGO

for safety and environment